

# Tanglewood Meeting Room

## 15' X 27' with 8' ceiling

Open Room

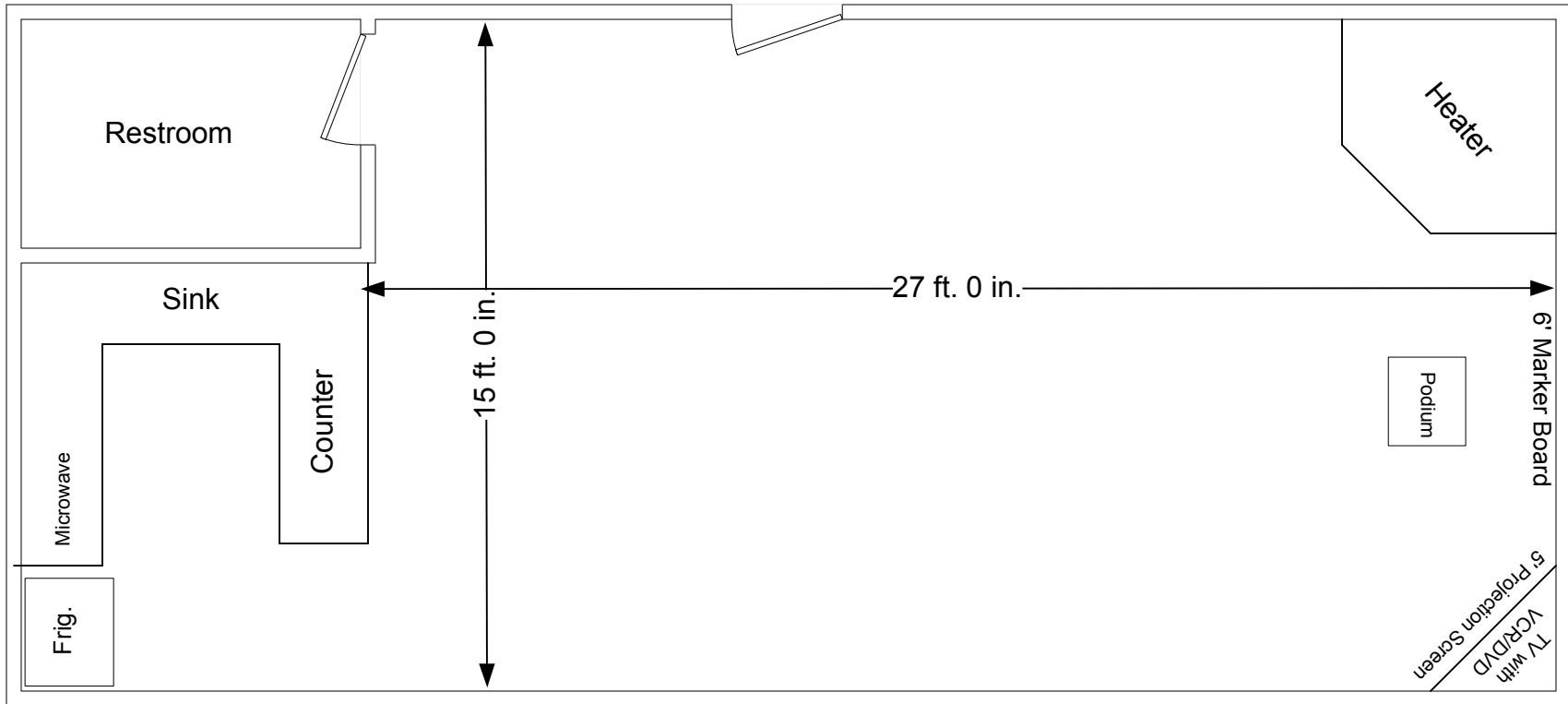

### Other Set Up Equipment Available

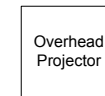
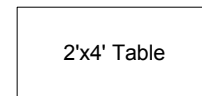
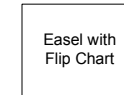
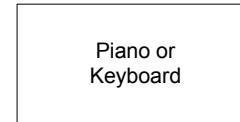
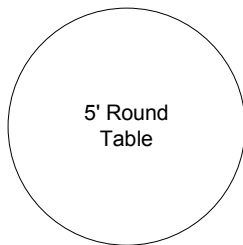

Scale - 1/4" = 1'

# Tanglewood Meeting Room

15' X 27' with 8' ceiling

Auditorium Style  
Seating for 36  
with no tables

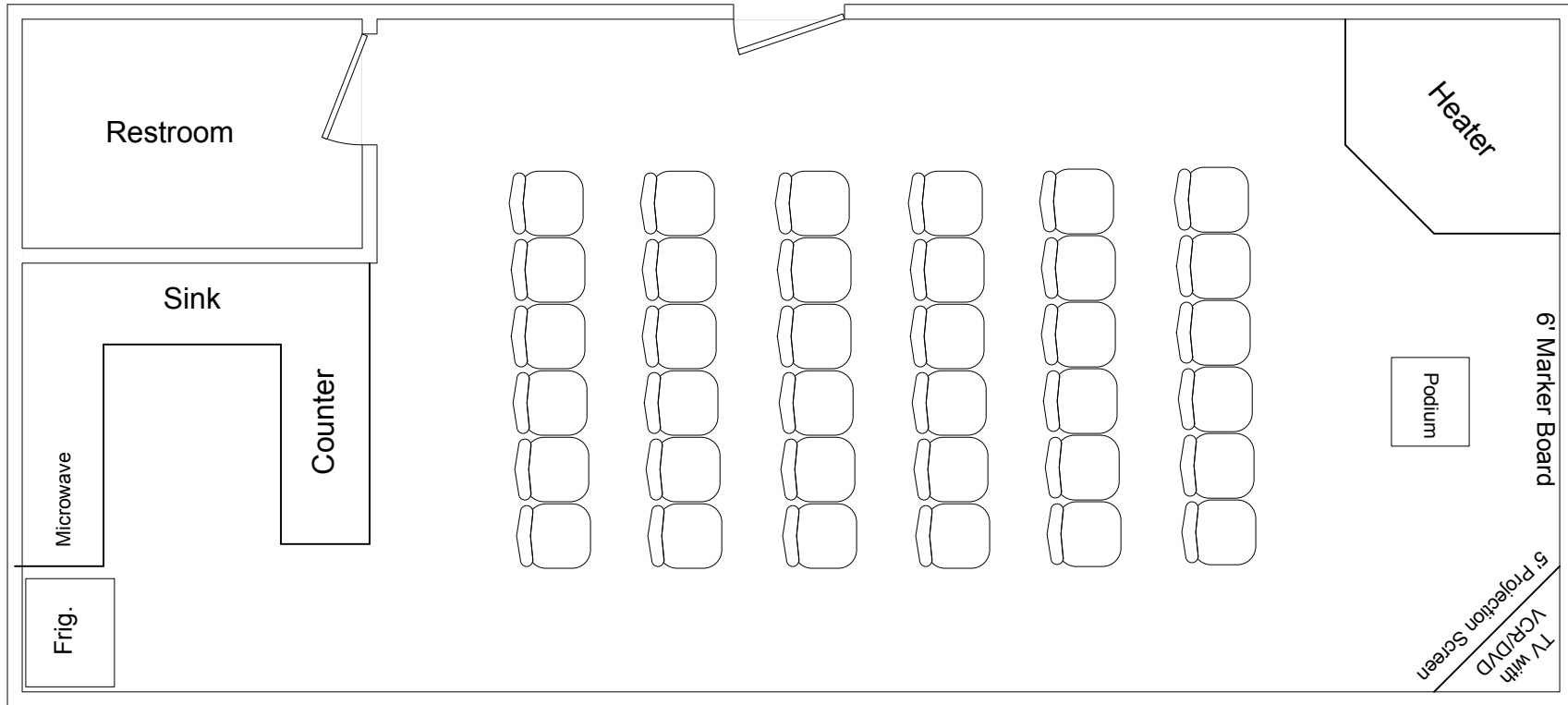

## Other Set Up Equipment Available

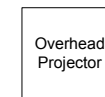
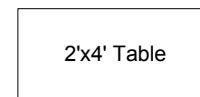
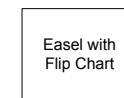
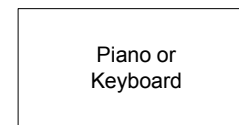
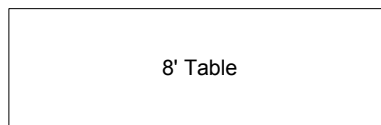
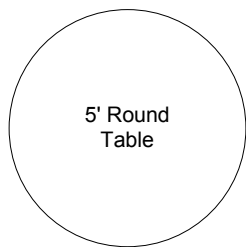

Scale - 1/4" = 1'

# Tanglewood Meeting Room

15' X 27' with 8' ceiling

Conference Style  
Seating for 16  
behind narrow tables

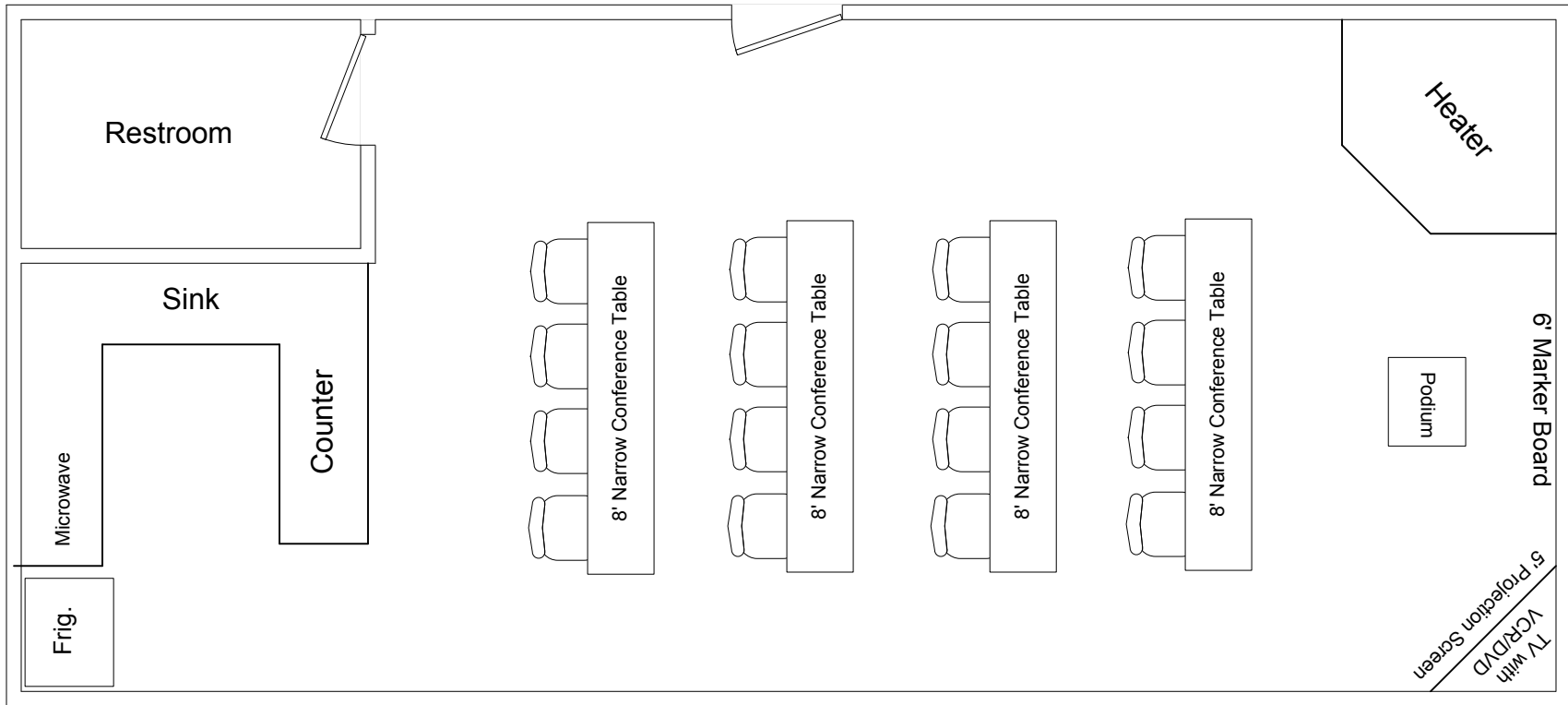

## Other Set Up Equipment Available

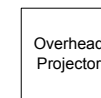
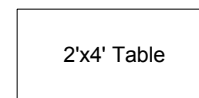
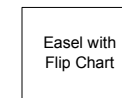
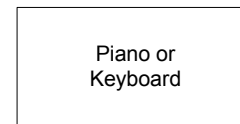
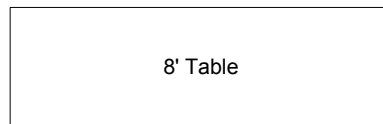
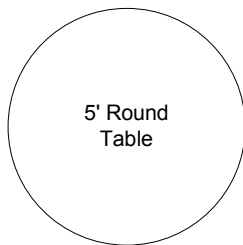

Scale - 1/4" = 1'

# Tanglewood Meeting Room

15' X 27' with 8' ceiling

Open Board Style  
Seating for 14  
behind 30" tables

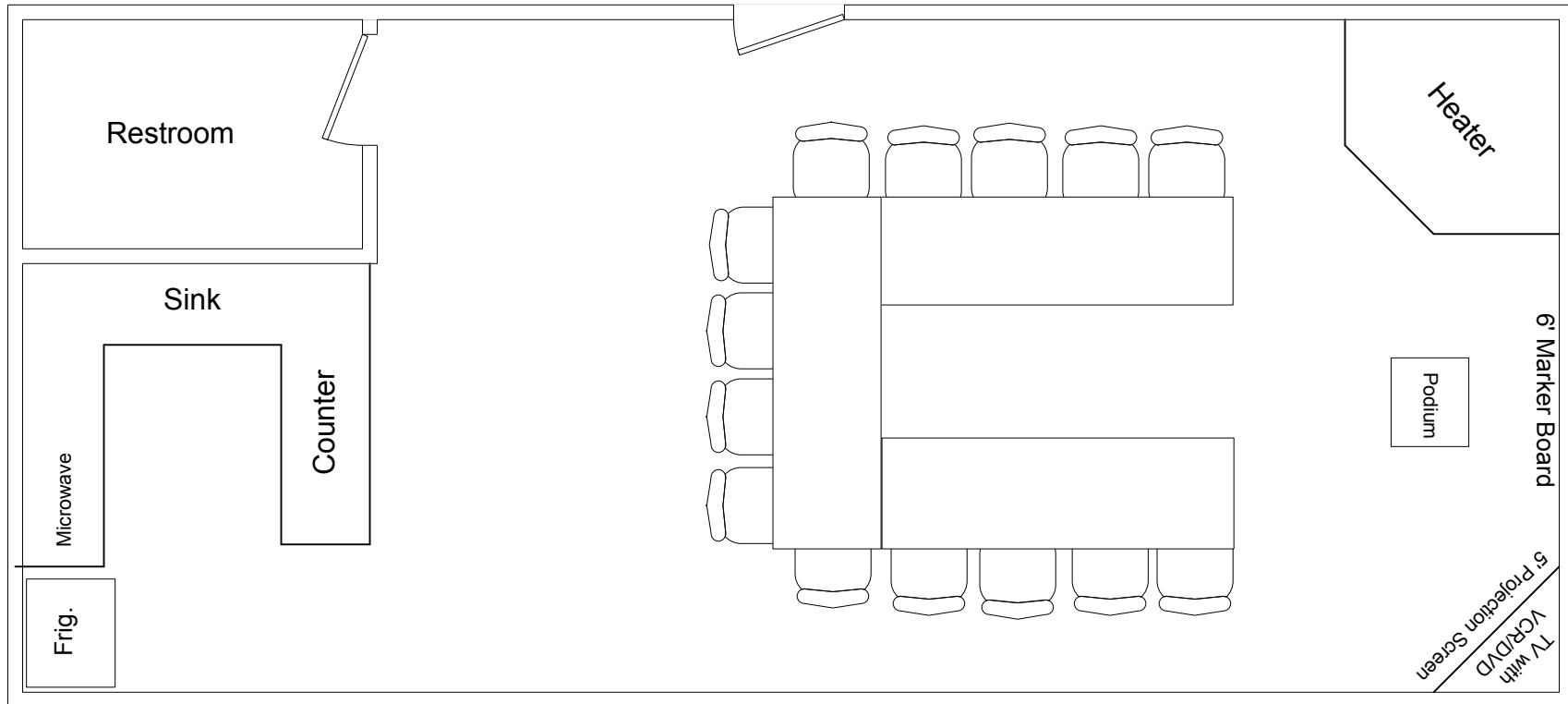

## Other Set Up Equipment Available

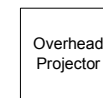
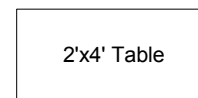
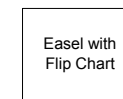
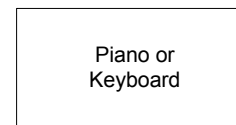
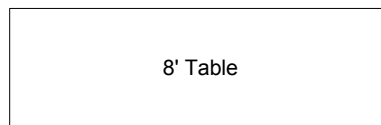
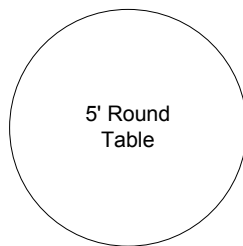

Scale - 1/4" = 1'

# Tanglewood Meeting Room

15' X 27' with 8' ceiling

Closed Board Style  
Seating for 20  
behind 30" tables

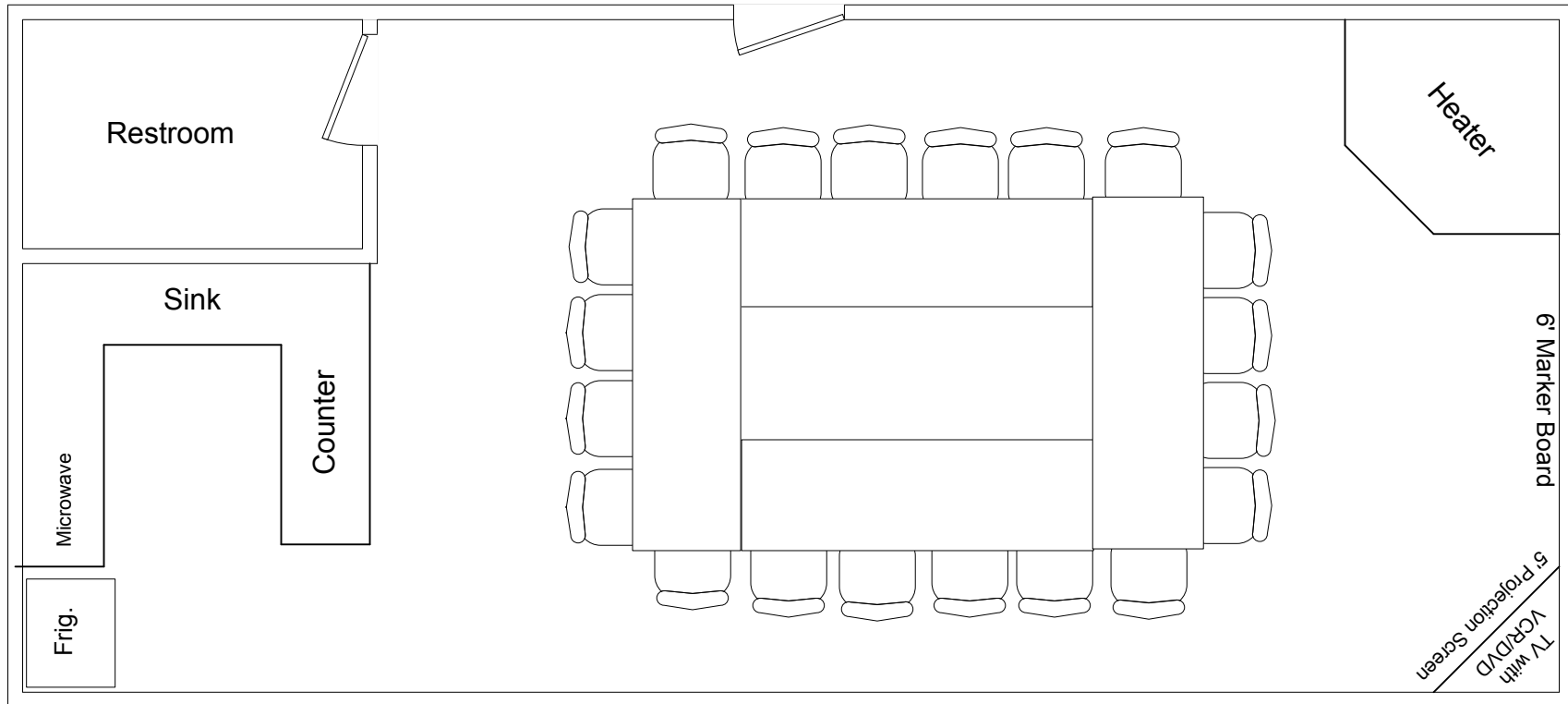

## Other Set Up Equipment Available

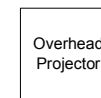
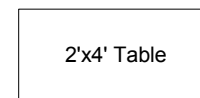
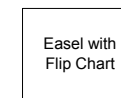
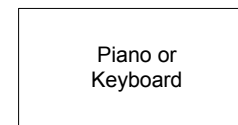
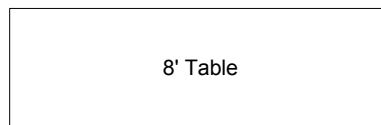
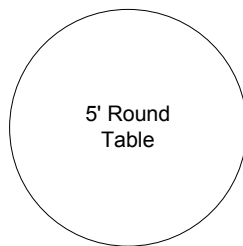

Scale - 1/4" = 1'

# Tanglewood Meeting Room

## 15' X 27' with 8' ceiling

Long Table Style  
Seating for 16

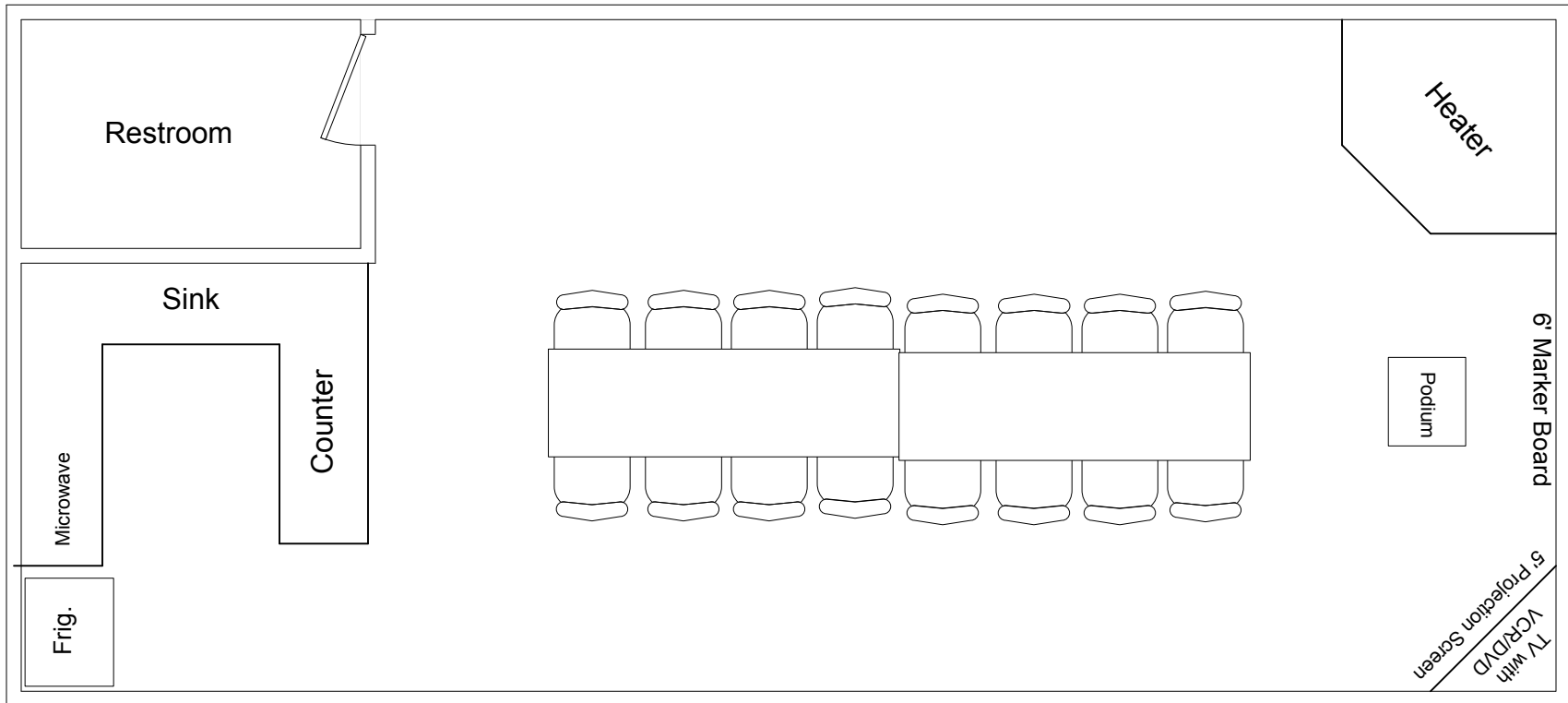

### Other Set Up Equipment Available

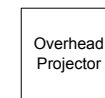
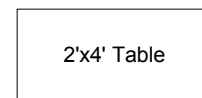
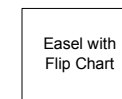
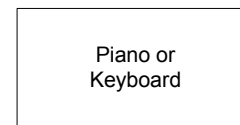
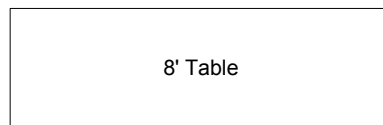
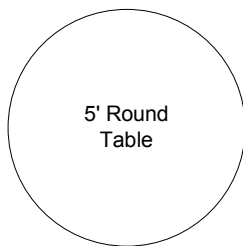

Scale - 1/4" = 1'

# Tanglewood Meeting Room

## 15' X 27' with 8' ceiling

### Circle Style

Single Open (As Pictured) - 23  
 Single Closed - 30

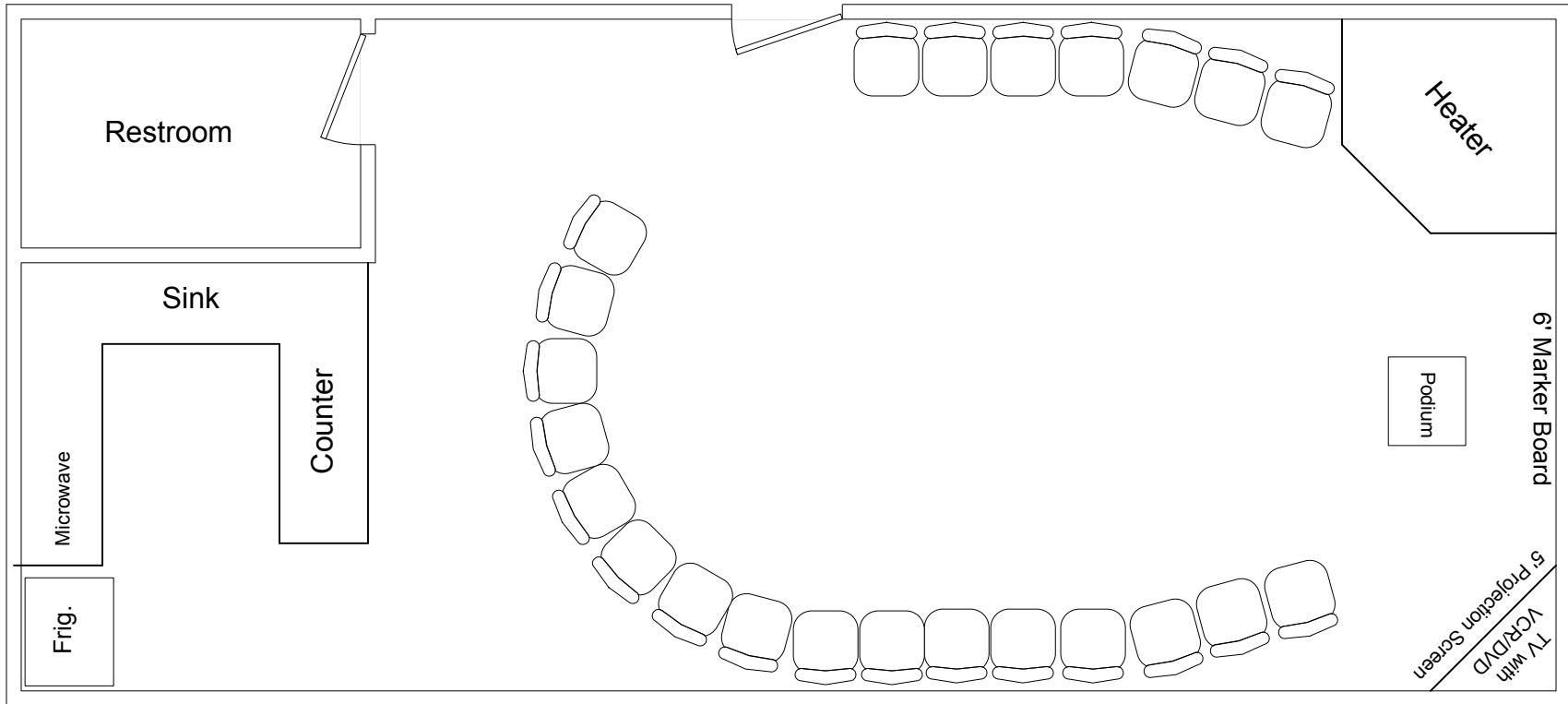

### Other Set Up Equipment Available

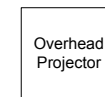
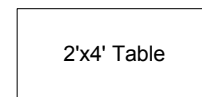
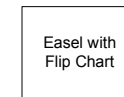
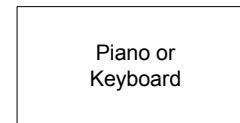
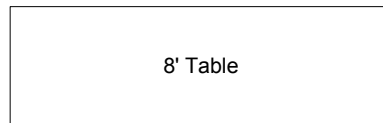
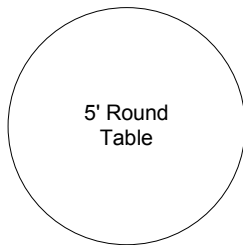

Scale - 1/4" = 1'